

FEATURES

- ❖ Low conversion loss
- ❖ LO frequency = ½ RF frequency
- ❖ Up to full waveguide band operation
- ❖ Compact and rugged package

APPLICATIONS

- ❖ Test equipment
- ❖ Communication systems
- ❖ Receivers

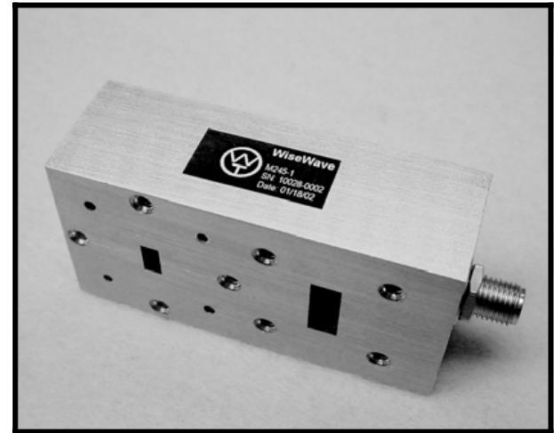

FDS Series

DESCRIPTION

FDS series balanced subharmonically pumped mixers are offered in seven waveguide bands to cover frequency spectra from 18 to 110 GHz. These mixers employ high performance GaAs Schottky beamlead diodes and balanced configuration to produce superior performance with a moderate LO pumping level. The mixers are designed for up to full RF waveguide band operation with wide IF bandwidth. Better performance can be obtained by operating the mixers in narrower bandwidth. The advantage to use subharmonically pumped mixers is their low LO frequency (½ RF frequency) characteristic, therefore, LO/RF frequency separation and their products treatment can be easily realized. In addition, lower LO frequency requirement will reduce system integration cost dramatically, especially, at higher millimeterwave frequency range. These mixers are ideal candidates for test equipment, communication systems and receivers where frequency down conversion is required.

SPECIFICATIONS

Waveguide Band	K	Ka	Q	U	V	E	W
RF Waveguide Size	WR-42	WR-28	WR-22	WR-19	WR-15	WR-12	WR-10
LO Connector	SMA	SMA or K	WG or K	WG or K	WG or K	WG or K	WG or V
RF Frequency Range (GHz)	18 to 26.5	26.5 to 40	33 to 50	40 to 60	50 to 75	60 to 90	75 to 110
LO Frequency Range (GHz)	9 to 13.25	13.25 to 20	16.5 to 25	20 to 30	25 to 37.5	30 to 45	37.5 to 55
IF Frequency Range (GHz)	DC to 4	DC to 6	DC to 8	DC to 10	DC to 12	DC to 15	DC to 18
LO Pumping Level (dBm)	10 to 15	10 to 15	12 to 15	12 to 15	12 to 15	12 to 15	12 to 15
Conversion Loss (dB, Typ)	10	11	12	13	14	15	16
Input Signal Level (max)	+ 20 dBm				+ 18 dBm		
Temperature Range	0 to +50°C						

HOW TO ORDER

Specify Model Number:

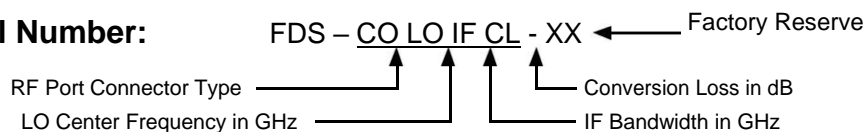

Example: To order a subharmonically pumped mixer with WR-22 waveguide, 21 GHz LO frequency, DC to 8 GHz IF bandwidth and 12 dB conversion loss, specify FDS-22210812-XX.

Frequency Converter Outline Drawings #1

WT-F-1

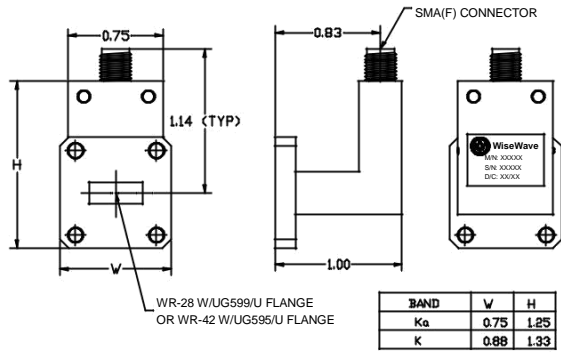

Dimensions are in inches

WT-F-2

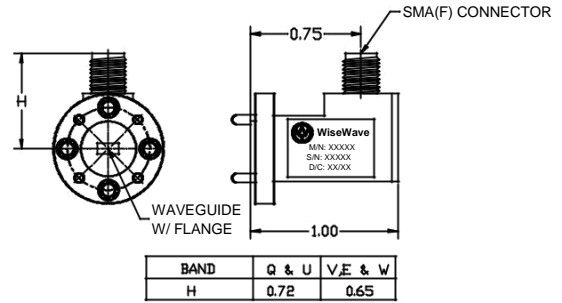

Dimensions are in inches

WT-F-3

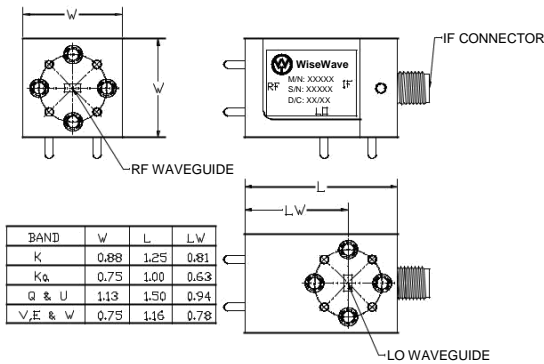

Dimensions are in inches

WT-F-4

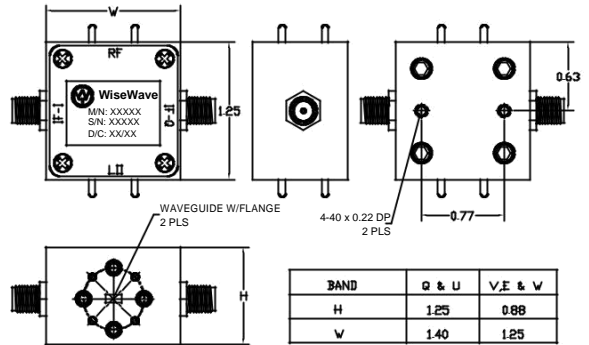

Dimensions are in inches

WT-F-5

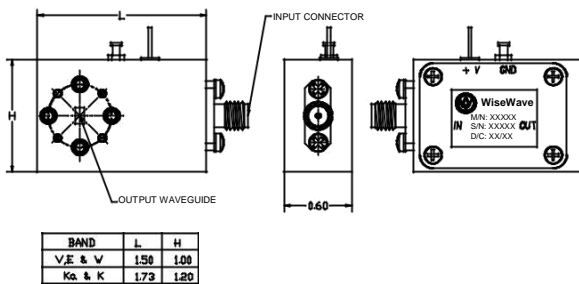

Dimensions are in inches

WT-F-6

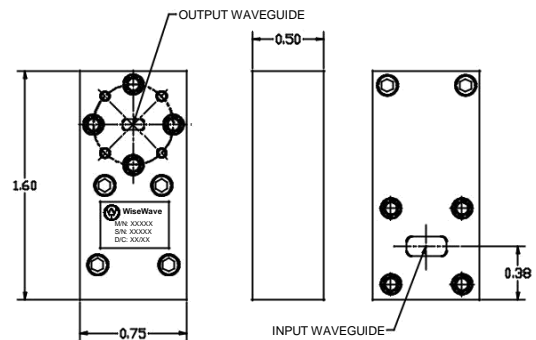

Dimensions are in inches

The flange pattern shown is for illustration purpose. Refer to Technical Reference Section for flange pattern details. The outline drawings shown are standard versions. Contact factory for your specific package requirements.

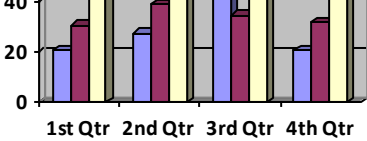

Frequency Converter Outline Drawings #2

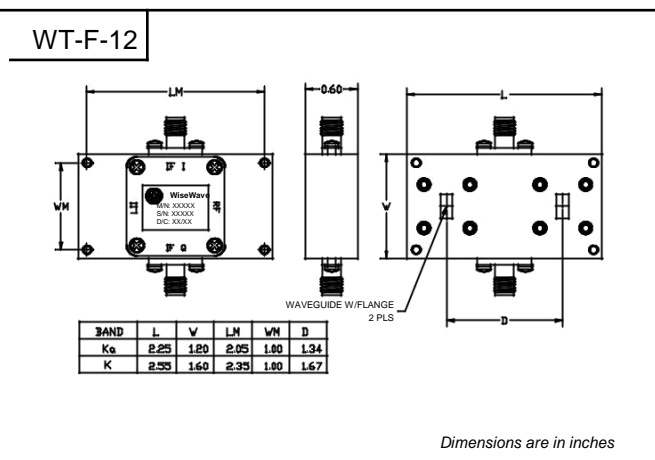
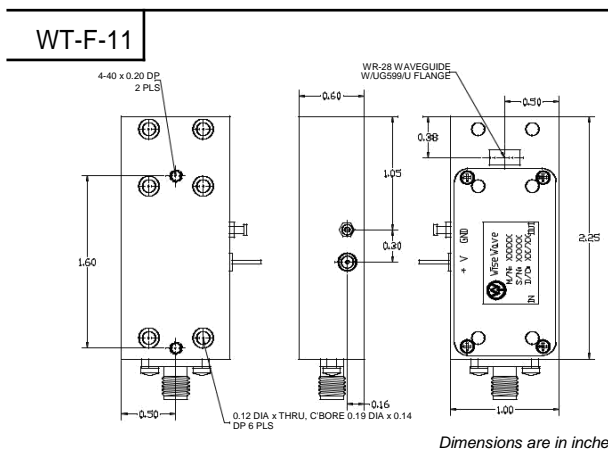
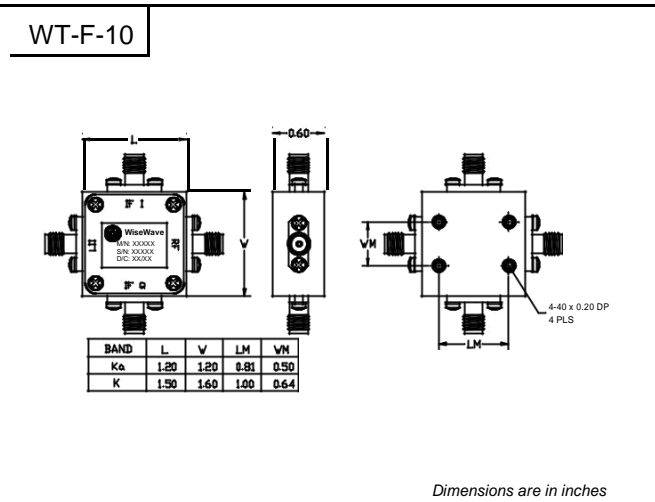
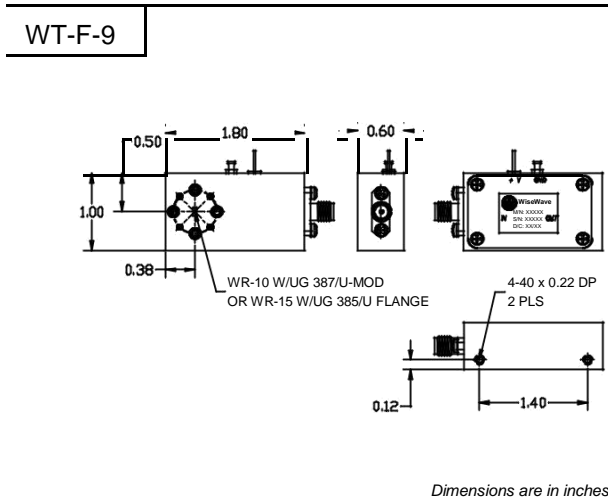
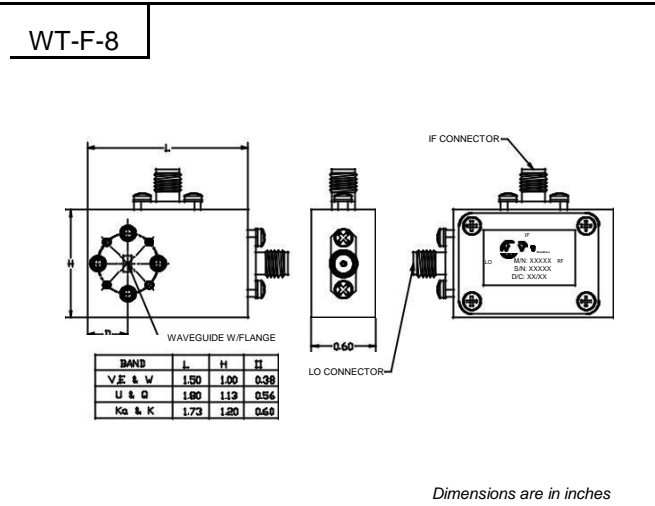
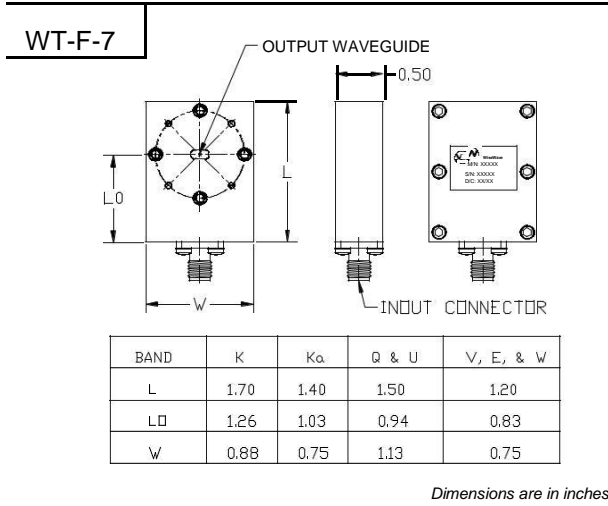

The flange pattern shown is for illustration purpose. Refer to Technical Reference Section for flange pattern details. The outline drawings shown are standard versions. Contact factory for your specific package requirements.