

FEATURES

- ❖ Full waveguide band operation
- ❖ Low insertion loss
- ❖ Low VSWR
- ❖ Rugged mechanical configuration

APPLICATIONS

- ❖ Test setups
- ❖ Instrumentation
- ❖ Subsystems
- ❖ Transceivers

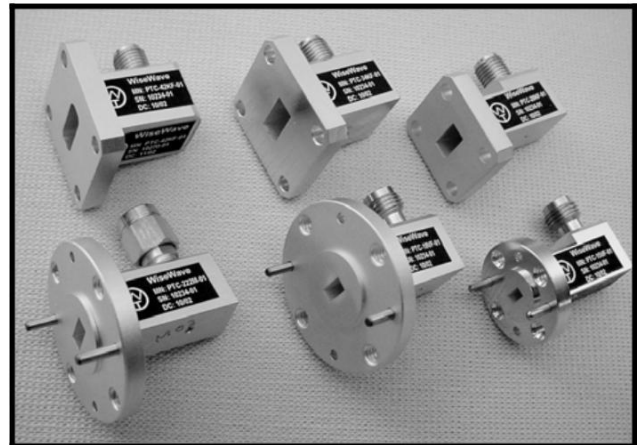

PTC Series

DESCRIPTION

PTC series waveguide to coax adapters are available in nine waveguide bands covering the frequency range of 8.2 to 70 GHz. The adapters covering 8.2 to 60 GHz frequency range are designed for full waveguide band operation, while V band one is for 50 to 70 GHz. These adapters are specially designed with exceptional high performance. SMA male or female connectors are standard coaxial line interfaces for WR-90, WR-75, WR-62 waveguide adapters. 2.92 mm (K) male or female connectors are for WR-42 and WR-28 waveguide adapters, while 2.4 mm male or female connectors are for WR-22 and V male or female connectors are for WR-19 and WR-15 waveguide adapters. The adapters are ideal choices where the waveguide to coaxial transitions are required.

SPECIFICATIONS

Model Number	Frequency (GHz)	Waveguide Size	Coax Connector	Insertion Loss (dB, Max)	Return Loss (dB, Min)	Flange Type	Outline Drawing
PTC-90SF-01	8.2 to 12.4	WR-90	SMA (F)	0.20	20.0	UG39/U	WT-E-5
PTC-90SM-01	8.2 to 12.4	WR-90	SMA (M)	0.20	20.0	UG39/U	WT-E-5
PTC-75SF-01	10.0 to 15.0	WR-75	SMA (F)	0.20	20.0	Square	WT-E-5
PTC-75SM-01	10.0 to 15.0	WR-75	SMA (M)	0.20	20.0	Square	WT-E-5
PTC-62SF-01	12.4 to 18.0	WR-62	SMA (F)	0.25	20.0	UG419/U	WT-E-5
PTC-62SM-01	12.4 to 18.0	WR-62	SMA (M)	0.25	20.0	UG419/U	WT-E-5
PTC-42KF-01	18.0 to 26.5	WR-42	K (F)	0.30	20.0	UG595/U	WT-E-5
PTC-42KM-01	18.0 to 26.5	WR-42	K (M)	0.30	20.0	UG595/U	WT-E-5
PTC-34KF-01	22.0 to 33.0	WR-34	K (F)	0.30	20.0	UG1530/U	WT-E-5
PTC-34KM-01	22.0 to 33.0	WR-34	K (M)	0.30	20.0	UG1530/U	WT-E-5
PTC-28KF-01	26.5 to 40.0	WR-28	K (F)	0.35	20.0	UG599/U	WT-E-5
PTC-28KM-01	26.5 to 40.0	WR-28	K (M)	0.35	20.0	UG599/U	WT-E-5
PTC-222F-01	33.0 to 50.0	WR-22	2.4 mm (F)	0.40	18.0	UG383/U	WT-E-5
PTC-222M-01	33.0 to 50.0	WR-22	2.4 mm (M)	0.40	18.0	UG383/U	WT-E-5
PTC-19VF-01	40.0 to 60.0	WR-19	V (F)	0.40	17.0	UG383/U-M	WT-E-5
PTC-19VM-01	40.0 to 60.0	WR-19	V (M)	0.40	17.0	UG383/U-M	WT-E-5
PTC-15VF-01	50.0 to 70.0	WR-15	V (F)	0.50	16.0	UG385/U	WT-E-5
PTC-15VM-01	50.0 to 70.0	WR-15	V (M)	0.50	16.0	UG385/U	WT-E-5

Note: The adapters with different type of coax interface and flange are available per request.

Passive Component Outline Drawings #1

WT-E-1

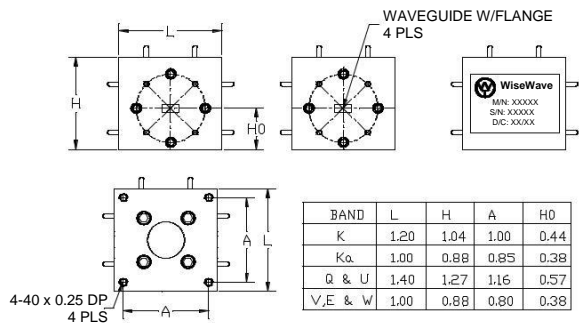

Dimensions are in inches

WT-E-2

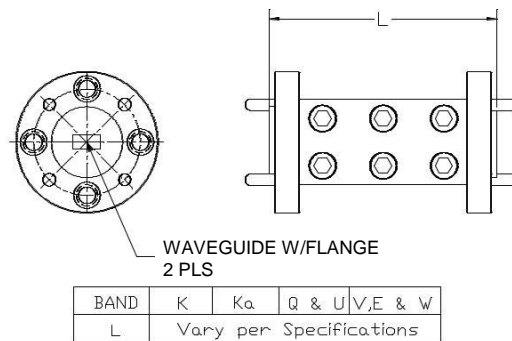

Dimensions are in inches

WT-E-3

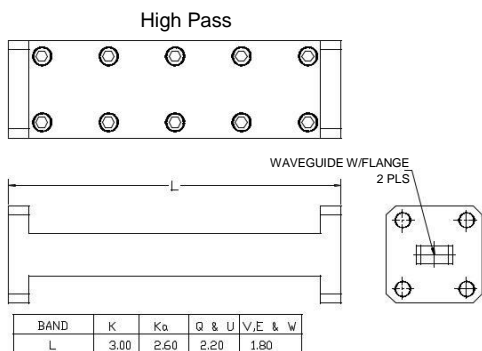

Dimensions are in inches

WT-E-4

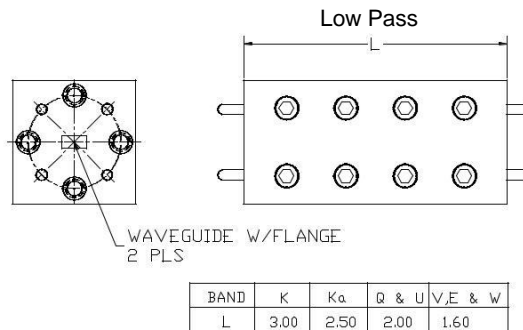

Dimensions are in inches

WT-E-5

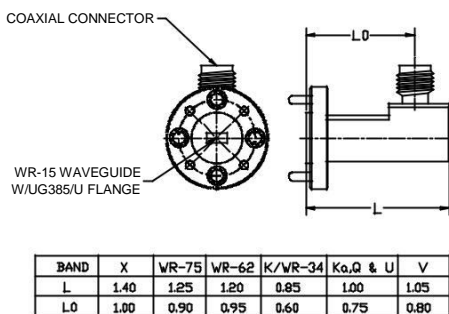

NOTES:
BOTH MALE AND FEMALE COAXIAL CONNECTORS ARE AVAILABLE FOR ALL BANDS

Dimensions are in inches

WT-E-6

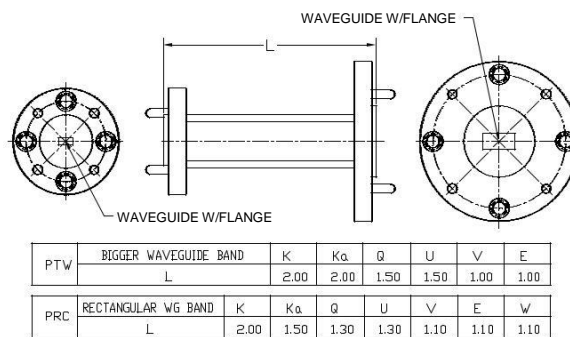

Dimensions are in inches

The flange pattern shown is for illustration purpose. Refer to Technical Reference Section for flange pattern details. The outline drawings shown are standard versions. Contact factory for your specific package requirements.

Passive Component Outline Drawings #2

WT-E-7

BAND	K	Ka	Q	U	V	E	W
L	1.20	1.00	1.30	1.30	1.00	1.00	1.00
W	1.20	1.00	1.30	1.30	1.00	1.00	1.00
H	1.06	0.90	1.25	1.23	0.83	0.82	0.81

Dimensions are in inches

WT-E-8

Band	X	VR-75	Ku	K	Ka	Q	U	V	E	W
L	5.46	4.80	4.66	4.24	3.46	3.26	2.66	2.56	2.56	2.46
A	1.73	1.65	1.58	1.52	1.23	1.23	0.98	0.98	0.98	0.98
D	0.45	0.43	0.35	0.21	0.18	0.15	0.13	0.11	0.10	0.09
H	3.46	3.30	3.16	3.04	2.46	2.46	1.96	1.96	1.96	1.96

Dimensions are in inches

WT-E-9

BAND	Q	U	V	E	W
L	5.50	5.50	3.50	3.50	3.50
W	1.30	1.30	1.00	1.00	1.00
H	1.25	1.23	0.83	0.82	0.81
A	0.80	0.80	0.60	0.60	0.60

Dimensions are in inches

WT-E-10

Band	X	VR-75	Ku	K	Ka	Q	U	V	E	W
L	19.50	16.50	13.00	11.00	10.00	8.00	6.50	6.00	5.50	5.00
A	1.90	1.85	1.75	1.50	1.40	1.20	1.20	1.00	1.00	1.00
B	0.95	0.95	0.90	0.70	0.60	0.70	0.70	0.60	0.60	0.60
D	0.45	0.43	0.35	0.21	0.18	0.15	0.13	0.11	0.10	0.09

Dimensions are in inches

WT-E-11

Dimensions are in inches

WT-E-12

Dimensions are in inches

The flange pattern shown is for illustration purpose. Refer to Technical Reference Section for flange pattern details. The outline drawings shown are standard versions. Contact factory for your specific package requirements.